

# BLF147

VHF power MOS transistor

Rev. 06 — 5 December 2006

Product data sheet

## IMPORTANT NOTICE

Dear customer,

As from October 1st, 2006 Philips Semiconductors has a new trade name - NXP Semiconductors, which will be used in future data sheets together with new contact details.

In data sheets where the previous Philips references remain, please use the new links as shown below.

<http://www.philips.semiconductors.com> use <http://www.nxp.com>

<http://www.semiconductors.philips.com> use <http://www.nxp.com> (Internet)

[sales.addresses@www.semiconductors.philips.com](mailto:sales.addresses@www.semiconductors.philips.com) use [salesaddresses@nxp.com](mailto:salesaddresses@nxp.com) (email)

The copyright notice at the bottom of each page (or elsewhere in the document, depending on the version)

- © Koninklijke Philips Electronics N.V. (year). All rights reserved -

is replaced with:

- © NXP B.V. (year). All rights reserved. -

If you have any questions related to the data sheet, please contact our nearest sales office via e-mail or phone (details via [salesaddresses@nxp.com](mailto:salesaddresses@nxp.com)). Thank you for your cooperation and understanding,

NXP Semiconductors

# VHF power MOS transistor

# BLF147

### FEATURES

- High power gain
- Low intermodulation distortion
- Easy power control
- Good thermal stability
- Withstands full load mismatch.

### APPLICATIONS

- Industrial and military applications in the HF/VHF frequency range.

### DESCRIPTION

Silicon N-channel enhancement mode vertical D-MOS transistor encapsulated in a 4-lead, SOT121B flange package with a ceramic cap. All leads are isolated from the flange. A marking code, showing gate-source voltage ( $V_{GS}$ ) information is provided for matched pair applications. Refer to the "General" section of the handbook for further information.

### PINNING - SOT121B

PIN	DESCRIPTION
1	drain
2	source
3	gate
4	source

CAUTION
This product is supplied in anti-static packing to prevent damage caused by electrostatic discharge during transport and handling. For further information, refer to Philips specs.: SNW-EQ-608, SNW-FQ-302A, and SNW-FQ-302B.

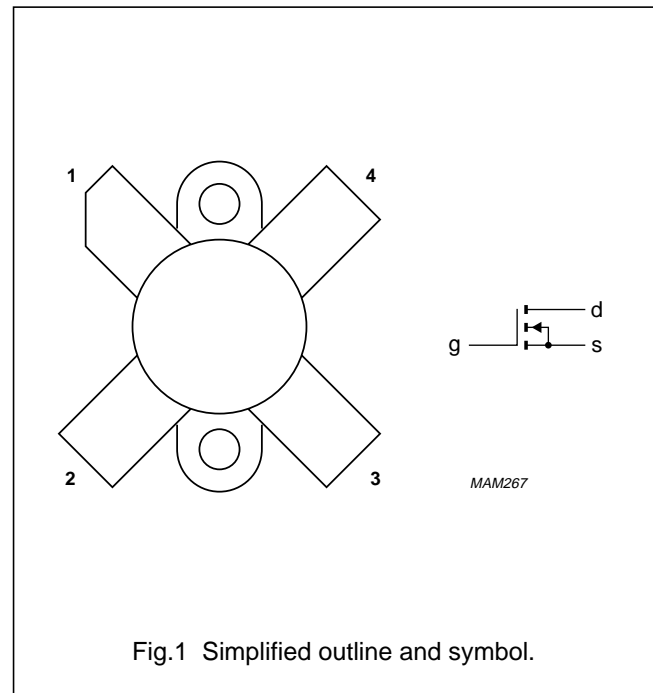

### QUICK REFERENCE DATA

RF performance at  $T_h = 25\text{ }^\circ\text{C}$  in a common source test circuit.

MODE OF OPERATION	f (MHz)	$V_{DS}$ (V)	$P_L$ (W)	$G_p$ (dB)	$\eta_D$ (%)	$d_3$ (dB)	$d_5$ (dB)
SSB, class-AB	28	28	150 (PEP)	>17	>35	<-30	<-30
CW, class-B	108	28	150	typ. 14	typ. 70	-	-

WARNING
<b>Product and environmental safety - toxic materials</b>
This product contains beryllium oxide. The product is entirely safe provided that the BeO disc is not damaged. All persons who handle, use or dispose of this product should be aware of its nature and of the necessary safety precautions. After use, dispose of as chemical or special waste according to the regulations applying at the location of the user. It must never be thrown out with the general or domestic waste.

VHF power MOS transistor

BLF147

**LIMITING VALUES**

In accordance with the Absolute Maximum System (IEC 60134).

SYMBOL	PARAMETER	CONDITIONS	MIN.	MAX.	UNIT
$V_{DS}$	drain-source voltage		–	65	V
$V_{GS}$	gate-source voltage		–	$\pm 20$	V
$I_D$	drain current (DC)		–	25	A
$P_{tot}$	total power dissipation	$T_{mb} \leq 25\text{ }^\circ\text{C}$	–	220	W
$T_{stg}$	storage temperature		–65	150	$^\circ\text{C}$
$T_j$	junction temperature		–	200	$^\circ\text{C}$

**THERMAL CHARACTERISTICS**

SYMBOL	PARAMETER	VALUE	UNIT
$R_{th\ j-mb}$	thermal resistance from junction to mounting base	0.8	K/W
$R_{th\ mb-h}$	thermal resistance from mounting base to heatsink	0.2	K/W

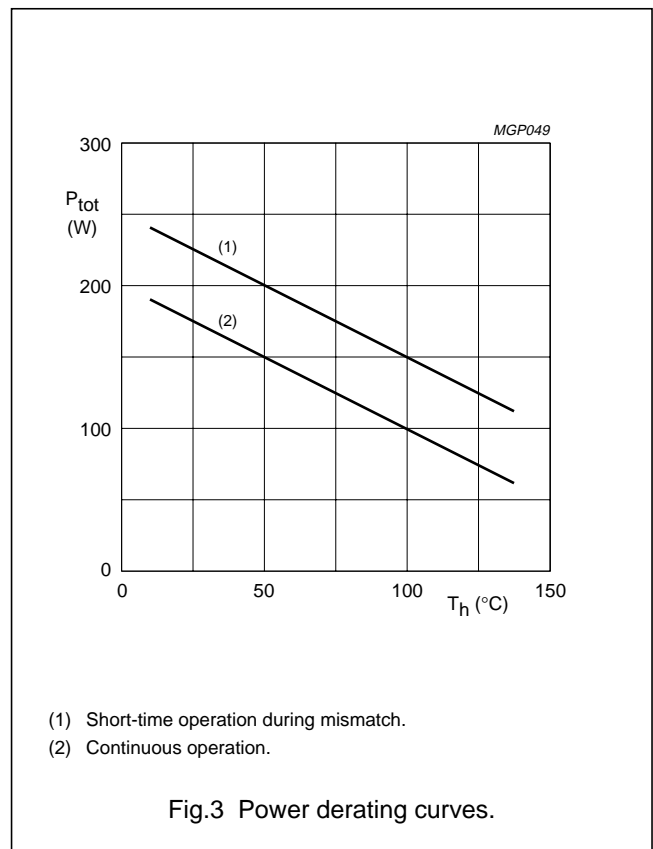
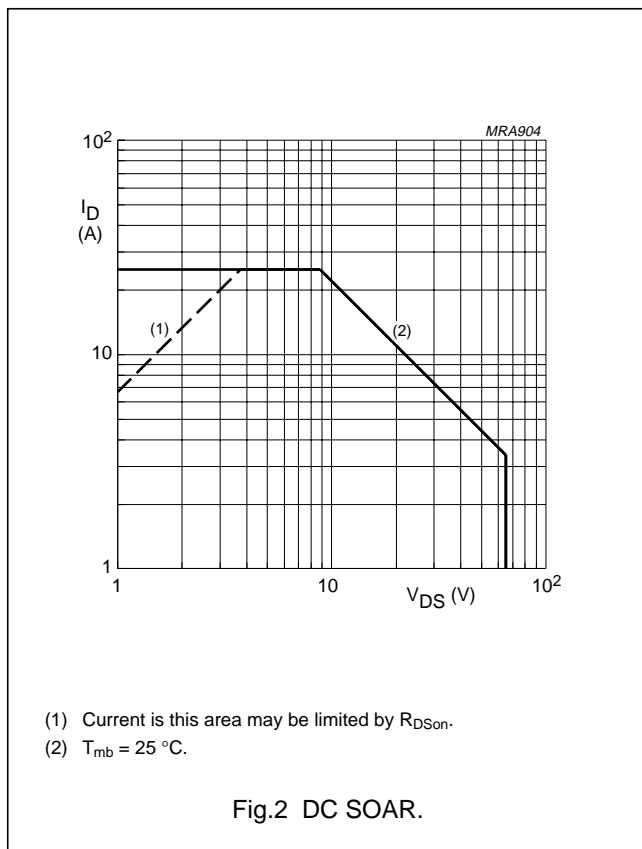

## VHF power MOS transistor

BLF147

## CHARACTERISTICS

 $T_j = 25\text{ }^\circ\text{C}$  unless otherwise specified.

SYMBOL	PARAMETER	CONDITIONS	MIN.	TYP.	MAX.	UNIT
$V_{(BR)DSS}$	drain-source breakdown voltage	$I_D = 100\text{ mA}$ ; $V_{GS} = 0$	65	–	–	V
$I_{DSS}$	drain-source leakage current	$V_{GS} = 0$ ; $V_{DS} = 28\text{ V}$	–	–	5	mA
$I_{GSS}$	gate-source leakage current	$V_{GS} = \pm 20\text{ V}$ ; $V_{DS} = 0$	–	–	1	$\mu\text{A}$
$V_{GSth}$	gate-source threshold voltage	$I_D = 200\text{ mA}$ ; $V_{DS} = 10\text{ V}$	2	–	4.5	V
$\Delta V_{GS}$	gate-source voltage difference of matched pairs	$I_D = 100\text{ mA}$ ; $V_{DS} = 10\text{ V}$	–	–	100	mV
$g_{fs}$	forward transconductance	$I_D = 8\text{ A}$ ; $V_{DS} = 10\text{ V}$	5	7.5	–	S
$R_{DSon}$	drain-source on-state resistance	$I_D = 8\text{ A}$ ; $V_{GS} = 10\text{ V}$	–	0.1	0.15	$\Omega$
$I_{DSX}$	on-state drain current	$V_{GS} = 10\text{ V}$ ; $V_{DS} = 10\text{ V}$	–	37	–	A
$C_{is}$	input capacitance	$V_{GS} = 0$ ; $V_{DS} = 28\text{ V}$ ; $f = 1\text{ MHz}$	–	450	–	pF
$C_{os}$	output capacitance	$V_{GS} = 0$ ; $V_{DS} = 28\text{ V}$ ; $f = 1\text{ MHz}$	–	360	–	pF
$C_{rs}$	feedback capacitance	$V_{GS} = 0$ ; $V_{DS} = 28\text{ V}$ ; $f = 1\text{ MHz}$	–	55	–	pF

 $V_{GS}$  group indicator

GROUP	LIMITS (V)		GROUP	LIMITS (V)	
	MIN.	MAX.		MIN.	MAX.
A	2.0	2.1	O	3.3	3.4
B	2.1	2.2	P	3.4	3.5
C	2.2	2.3	Q	3.5	3.6
D	2.3	2.4	R	3.6	3.7
E	2.4	2.5	S	3.7	3.8
F	2.5	2.6	T	3.8	3.9
G	2.6	2.7	U	3.9	4.0
H	2.7	2.8	V	4.0	4.1
J	2.8	2.9	W	4.1	4.2
K	2.9	3.0	X	4.2	4.3
L	3.0	3.1	Y	4.3	4.4
M	3.1	3.2	Z	4.4	4.5
N	3.2	3.3			

VHF power MOS transistor

BLF147

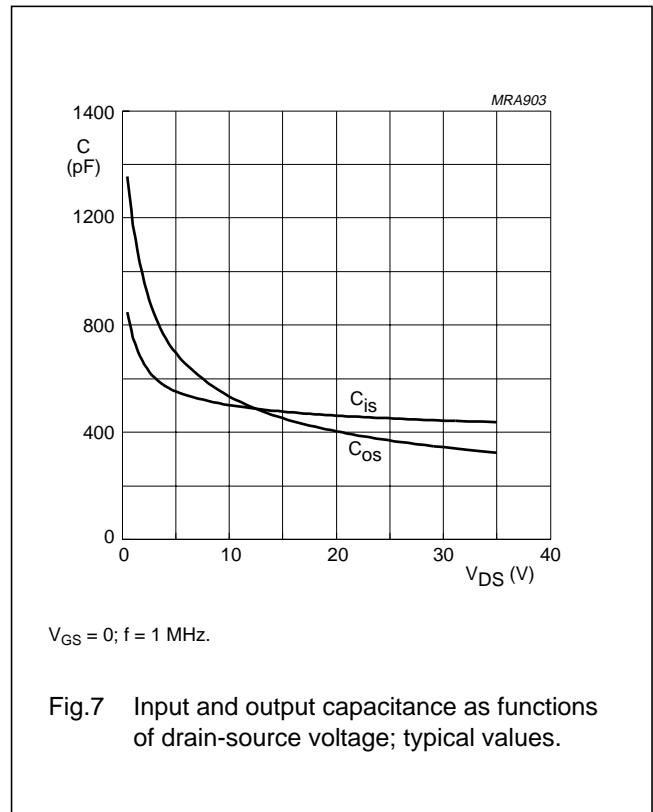
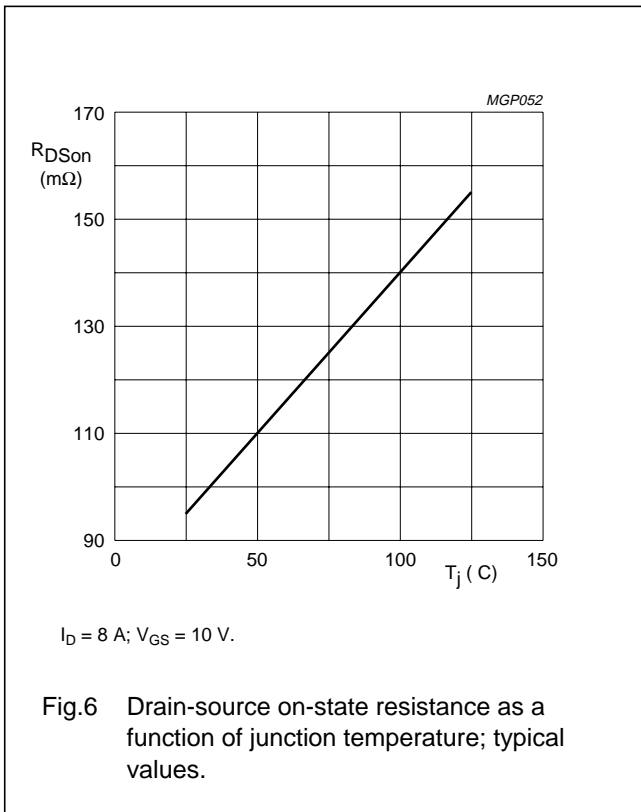
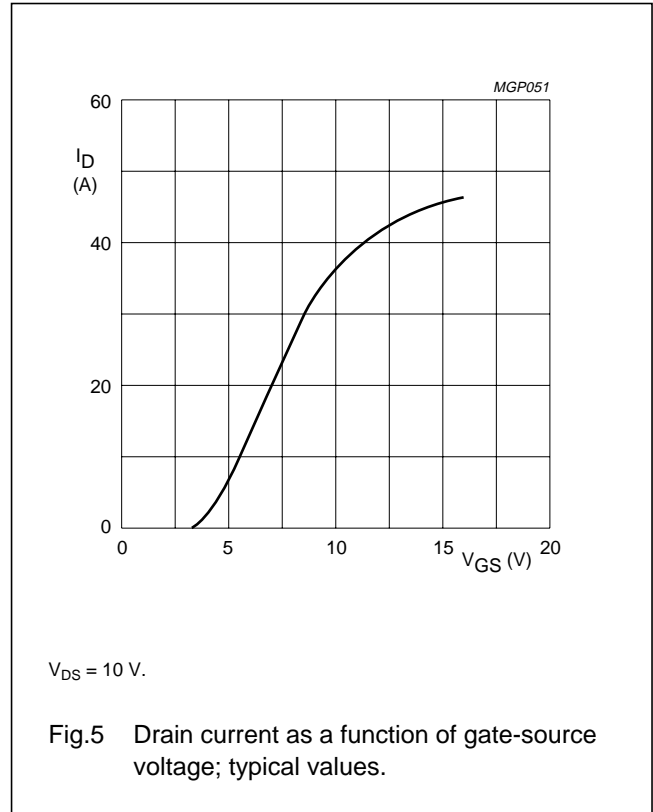
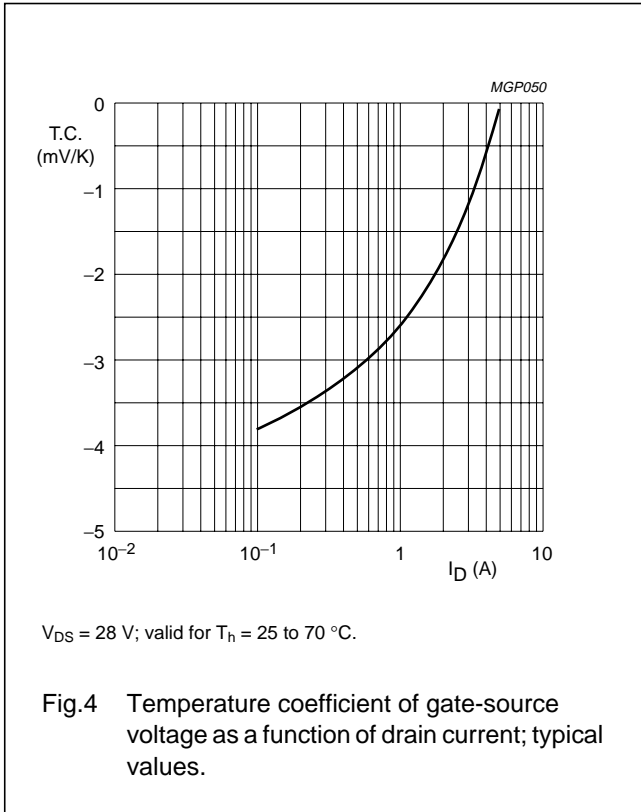

VHF power MOS transistor

BLF147

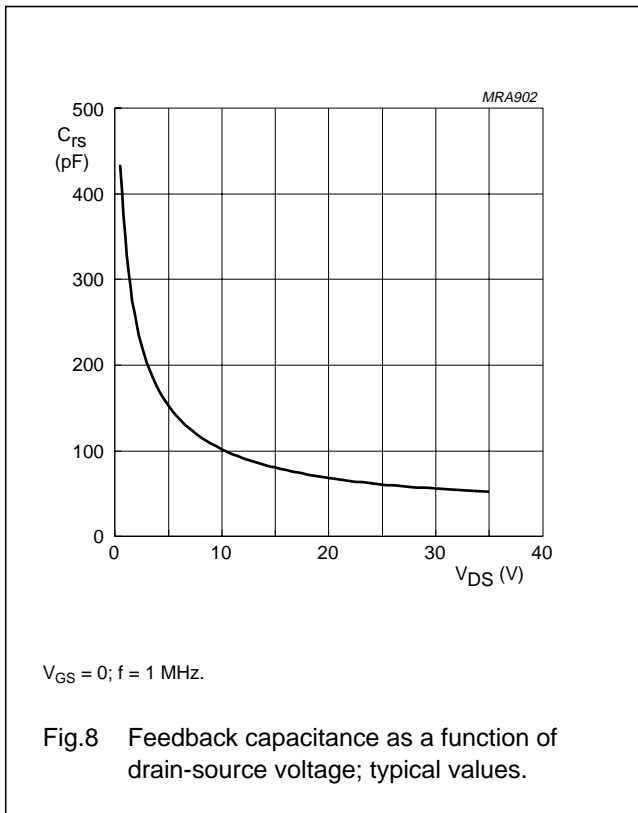

**APPLICATION INFORMATION FOR CLASS-AB OPERATION**

RF performance in SSB operation in a common source class-AB circuit.

$T_h = 25 \text{ }^\circ\text{C}; R_{th\text{ mb-h}} = 0.2 \text{ K/W}; R_{GS} = 9.8 \text{ } \Omega; f_1 = 28.000 \text{ MHz}; f_2 = 28.001 \text{ MHz};$  unless otherwise specified.

$P_L$ (W)	f (MHz)	$V_{DS}$ (V)	$I_{DQ}$ (A)	$G_p$ (dB)	$\eta_D$ (%)	$d_3$ (dB) (note 2)	$d_5$ (dB) (note 2)
20 to 150 (PEP)	28	28	1	>17 typ. 19	>35 typ. 40	<-30 typ. -34	<-30 typ. -40

**Notes**

- Optimum load impedance:  $2.1 + j0 \text{ } \Omega$ .
- Maximum values at drive levels within the specified PEP values for either amplified tone. For the peak envelope power the values should be decreased by 6 dB.

**Ruggedness in class-AB operation**

The BLF147 is capable of withstanding a load mismatch corresponding to  $VSWR = 50:1$  through all phases under the following conditions:  $V_{DS} = 28 \text{ V}; f = 28 \text{ MHz}$  at rated load power.

VHF power MOS transistor

BLF147

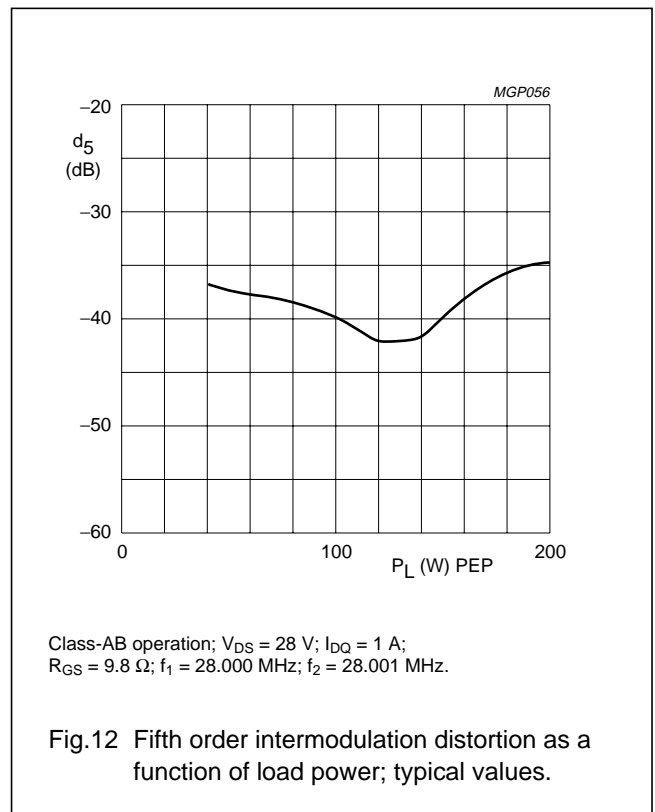
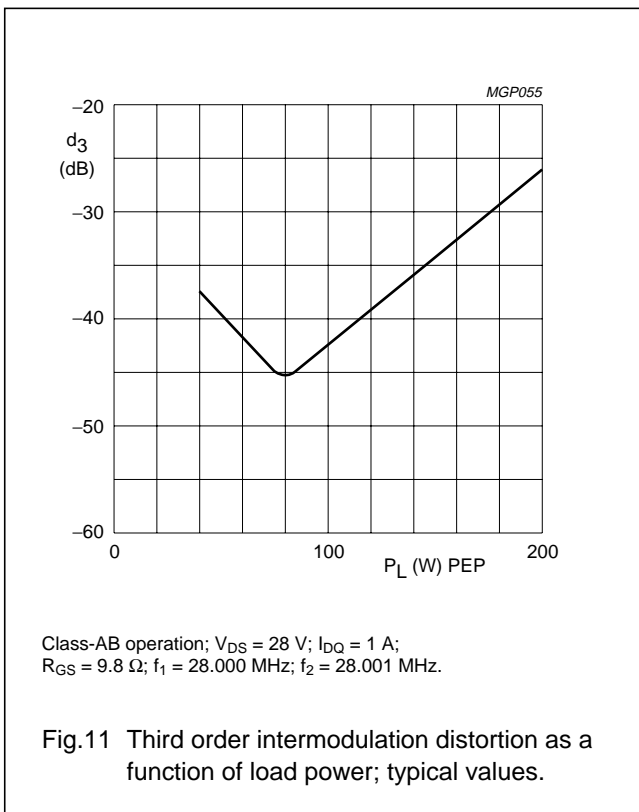
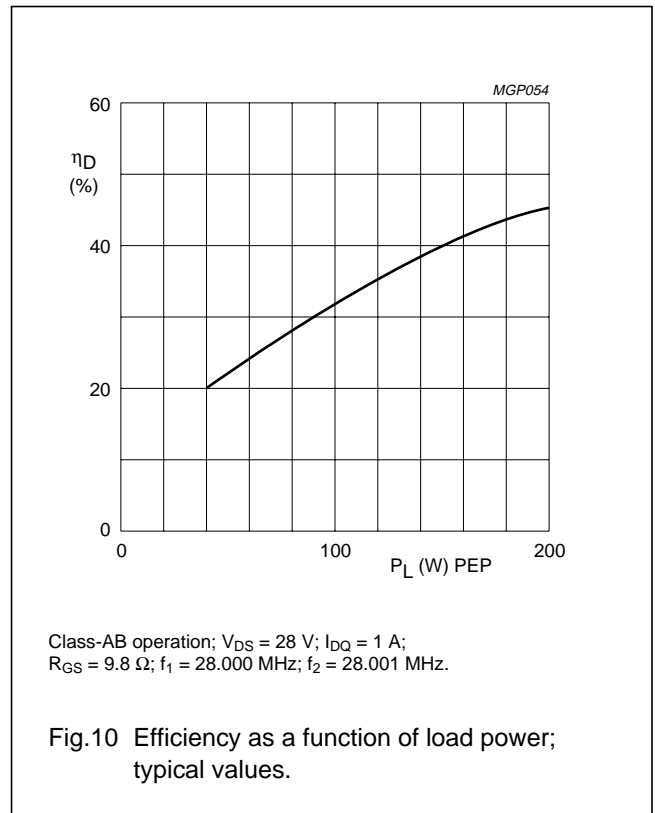
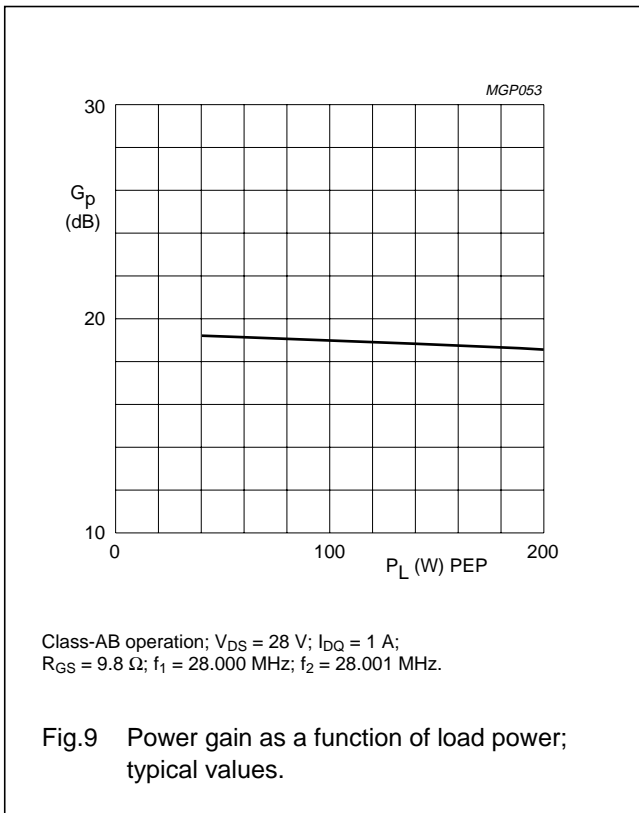

VHF power MOS transistor

BLF147

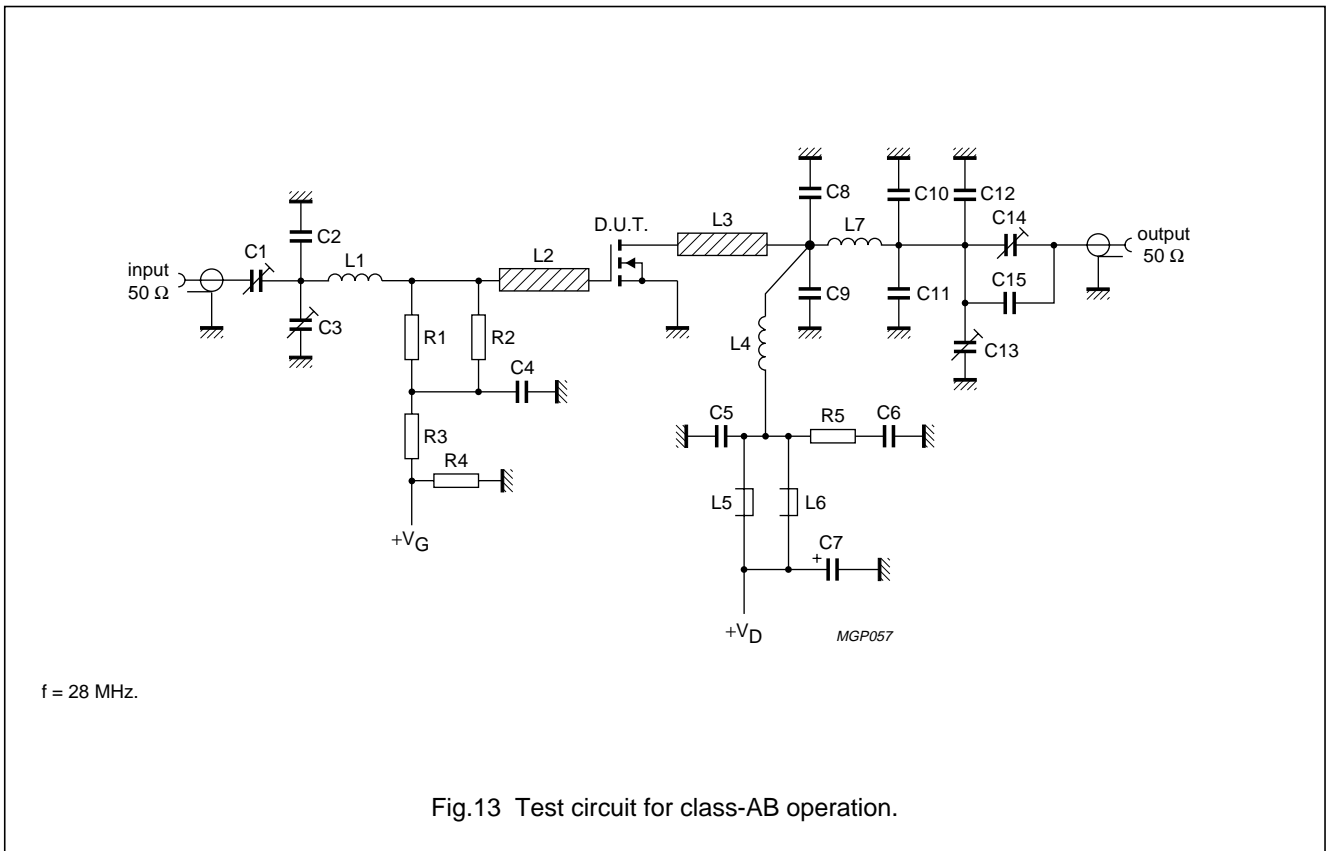



## VHF power MOS transistor

BLF147

List of components (see Fig 13).

COMPONENT	DESCRIPTION	VALUE	DIMENSIONS	CATALOGUE NO.
C1, C3, C13, C14	film dielectric trimmer	7 to 100 pF		2222 809 07015
C2, C8, C9	multilayer ceramic chip capacitor; note 1	75 pF		
C4, C5	multilayer ceramic chip capacitor	100 nF		2222 852 47104
C6	multilayer ceramic chip capacitors in parallel	3 × 100 nF		2222 852 47104
C7	electrolytic capacitor	2.2 μF, 63 V		
C10	multilayer ceramic chip capacitor; note 1	100 pF		
C11, C12	multilayer ceramic chip capacitor; note 1	150 pF		
C15	multilayer ceramic chip capacitor; note 1	240 pF		
L1	6 turns enamelled 0.7 mm copper wire	145 nH	length 5 mm; int. dia. 6 mm; leads 2 × 5 mm	
L2, L3	stripline; note 2	41.1 Ω	length 13 × 6 mm	
L4	4 turns enamelled 1.5 mm copper wire	148 nH	length 8 mm; int. dia. 10 mm; leads 2 × 5 mm	
L5, L6	grade 3B Ferroxcube wideband HF choke			4312 020 36642
L7	3 turns enamelled 2.2 mm copper wire	79 nH	length 8 mm; int. dia. 8 mm; leads 2 × 5 mm	
R1, R2	1 W metal film resistor	19.6 Ω		2322 153 51969
R3	0.4 W metal film resistor	10 kΩ		2322 151 71003
R4	0.4 W metal film resistor	1 MΩ		2322 151 71005
R5	1 W metal film resistor	10 Ω		2322 153 51009

**Notes**

- American Technical Ceramics (ATC) capacitor, type 100B or other capacitor of the same quality.
- The striplines are on a double copper-clad printed circuit board, with PTFE fibre-glass dielectric ( $\epsilon_r = 2.2$ ), thickness 1.6 mm.

VHF power MOS transistor

BLF147

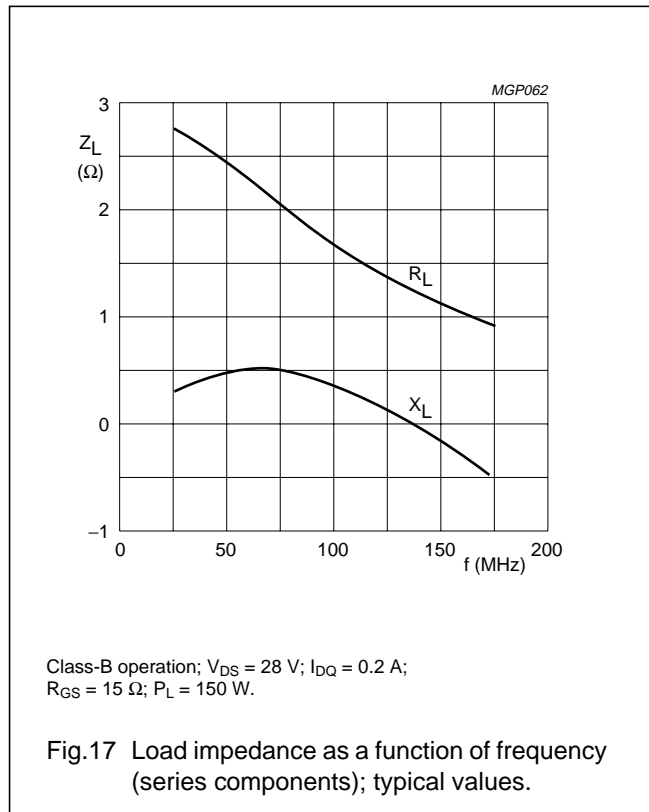
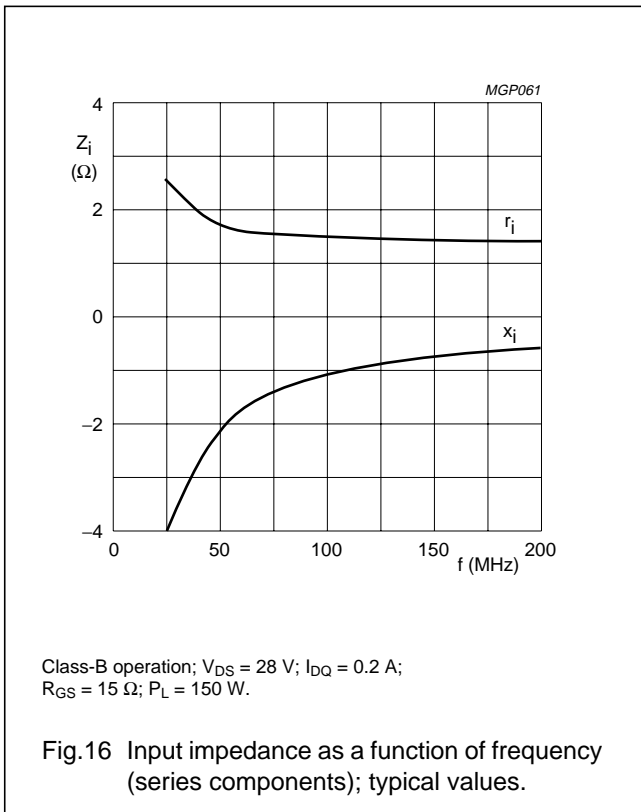
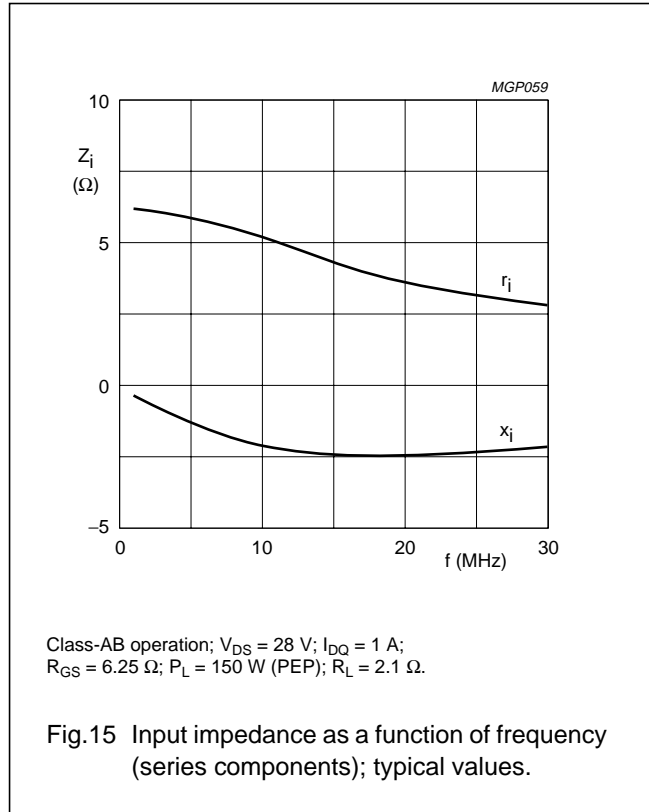
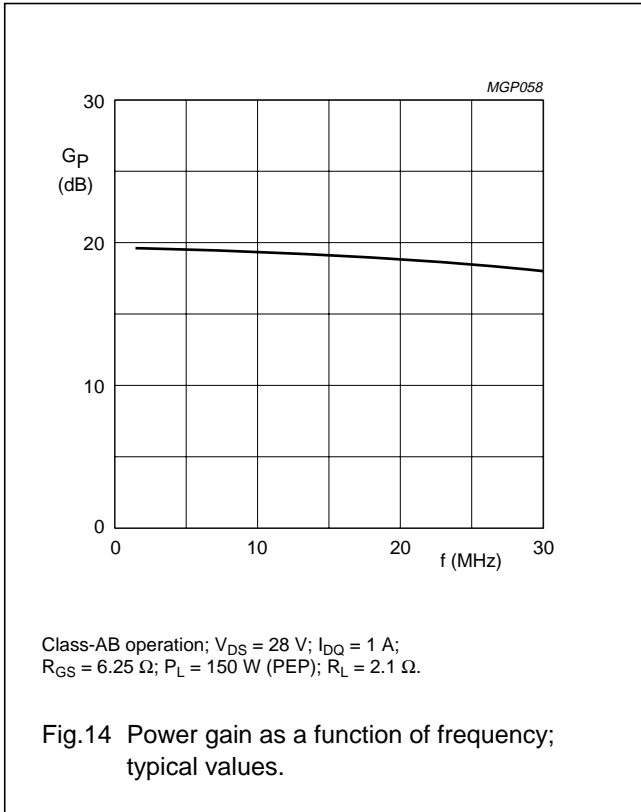

VHF power MOS transistor

BLF147

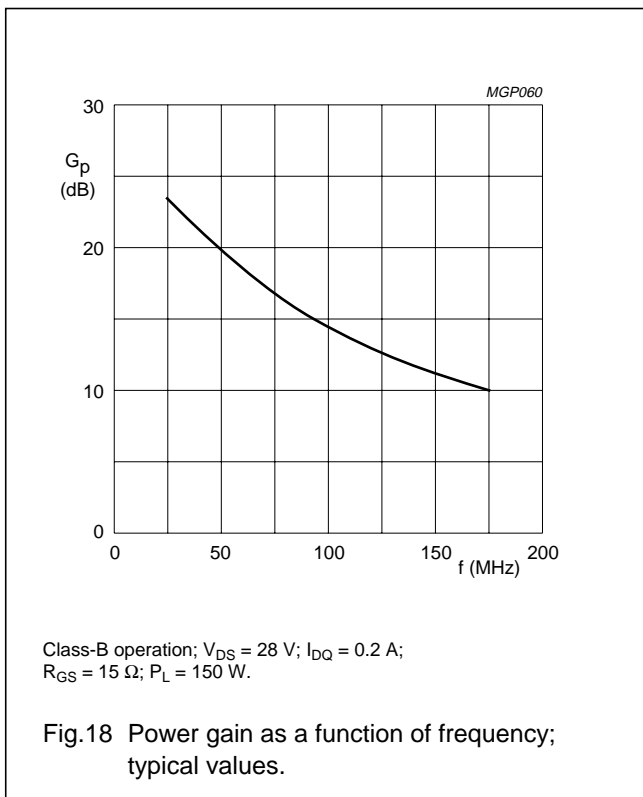

## VHF power MOS transistor

BLF147

**BLF147 scattering parameters** $V_{DS} = 28\text{ V}$ ;  $I_D = 1000\text{ mA}$ ; note 1

f (MHz)	S <sub>11</sub>		S <sub>21</sub>		S <sub>12</sub>		S <sub>22</sub>	
	S <sub>11</sub>	∠ Φ	S <sub>21</sub>	∠ Φ	S <sub>12</sub>	∠ Φ	S <sub>22</sub>	∠ Φ
5	0.91	-170.00	23.90	93.40	0.01	5.80	0.88	-171.20
10	0.91	-174.60	12.25	89.40	0.01	3.60	0.89	-177.20
20	0.92	-177.40	5.94	81.00	0.01	5.40	0.83	-179.60
30	0.92	-178.40	3.87	79.10	0.01	8.90	0.86	-178.90
40	0.92	-178.80	2.84	75.70	0.01	12.00	0.85	-178.60
50	0.92	-178.80	2.26	73.30	0.01	16.90	0.87	-176.90
60	0.92	-179.00	1.88	69.80	0.01	20.30	0.90	-177.30
70	0.93	-179.20	1.58	66.20	0.01	24.00	0.90	-178.10
80	0.93	-179.60	1.36	63.20	0.01	28.80	0.90	-178.40
90	0.93	-179.70	1.19	60.40	0.01	34.20	0.90	-178.60
100	0.94	-179.70	1.05	57.00	0.01	39.30	0.90	-179.40
125	0.95	179.50	0.77	49.30	0.01	52.30	0.88	179.20
150	0.95	179.00	0.60	45.80	0.01	64.90	0.91	-179.50
175	0.96	178.10	0.49	41.50	0.02	72.40	0.95	179.80
200	0.96	177.50	0.40	36.80	0.02	75.80	0.94	177.70
250	0.97	175.80	0.28	33.20	0.03	82.30	0.95	176.20
300	0.98	174.20	0.22	30.10	0.03	83.00	0.96	173.60
350	0.98	172.70	0.17	31.00	0.04	85.00	0.97	171.90
400	0.98	171.10	0.14	32.40	0.05	84.90	0.97	169.50
450	0.98	169.50	0.12	36.10	0.05	85.90	0.97	167.70
500	0.98	167.90	0.11	39.90	0.06	84.30	0.98	165.50
600	0.98	164.80	0.10	50.20	0.07	83.20	0.97	161.50
700	0.98	161.60	0.10	57.90	0.09	81.70	0.97	157.50
800	0.98	158.20	0.11	63.70	0.10	81.00	0.97	153.50
900	0.97	154.60	0.13	67.20	0.12	79.50	0.97	149.30
1000	0.97	151.10	0.14	70.20	0.14	78.80	0.96	144.90

**Note**

1. For more extensive S-parameters see internet:  
<http://www.semiconductors.philips.com/markets/communications/wirelesscommunications/broadcast>.

VHF power MOS transistor

BLF147

PACKAGE OUTLINE

Flanged ceramic package; 2 mounting holes; 4 leads

SOT121B

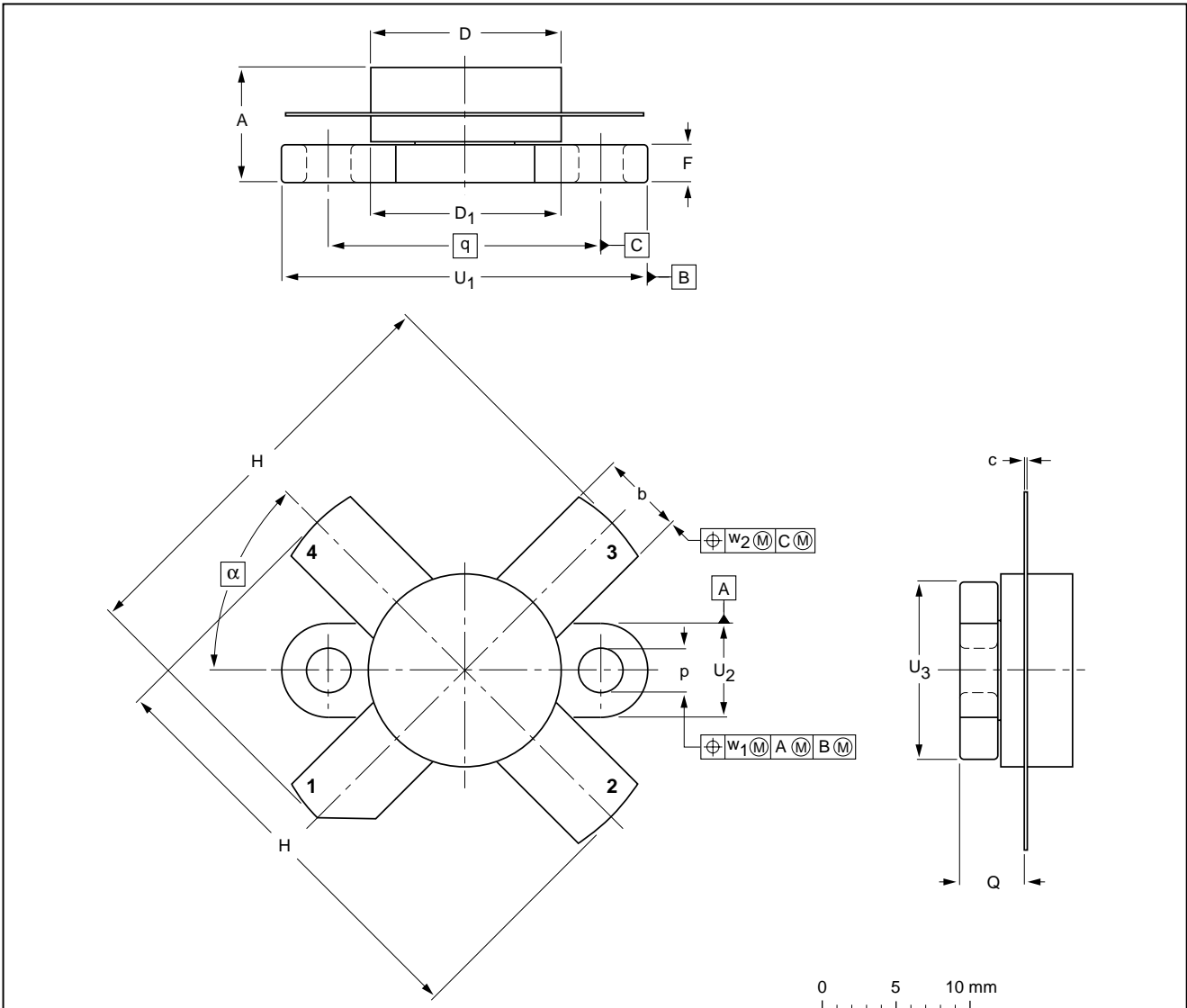

DIMENSIONS (millimetre dimensions are derived from the original inch dimensions)

UNIT	A	b	c	D	D <sub>1</sub>	F	H	p	Q	q	U <sub>1</sub>	U <sub>2</sub>	U <sub>3</sub>	w <sub>1</sub>	w <sub>2</sub>	α
mm	7.27 6.17	5.82 5.56	0.16 0.10	12.86 12.59	12.83 12.57	2.67 2.41	28.45 25.52	3.30 3.05	4.45 3.91	18.42	24.90 24.63	6.48 6.22	12.32 12.06	0.25	0.51	45°
inches	0.286 0.243	0.229 0.219	0.006 0.004	0.506 0.496	0.505 0.495	0.105 0.095	1.120 1.005	0.130 0.120	0.175 0.154	0.725	0.98 0.97	0.255 0.245	0.485 0.475	0.01	0.02	

OUTLINE VERSION	REFERENCES				EUROPEAN PROJECTION	ISSUE DATE
	IEC	JEDEC	EIAJ			
SOT121B						99-03-29

## Legal information

### Data sheet status

Document status <sup>[1][2]</sup>	Product status <sup>[3]</sup>	Definition
Objective [short] data sheet	Development	This document contains data from the objective specification for product development.
Preliminary [short] data sheet	Qualification	This document contains data from the preliminary specification.
Product [short] data sheet	Production	This document contains the product specification.

[1] Please consult the most recently issued document before initiating or completing a design.

[2] The term 'short data sheet' is explained in section "Definitions".

[3] The product status of device(s) described in this document may have changed since this document was published and may differ in case of multiple devices. The latest product status information is available on the Internet at URL <http://www.nxp.com>.

### Definitions

**Draft** — The document is a draft version only. The content is still under internal review and subject to formal approval, which may result in modifications or additions. NXP Semiconductors does not give any representations or warranties as to the accuracy or completeness of information included herein and shall have no liability for the consequences of use of such information.

**Short data sheet** — A short data sheet is an extract from a full data sheet with the same product type number(s) and title. A short data sheet is intended for quick reference only and should not be relied upon to contain detailed and full information. For detailed and full information see the relevant full data sheet, which is available on request via the local NXP Semiconductors sales office. In case of any inconsistency or conflict with the short data sheet, the full data sheet shall prevail.

### Disclaimers

**General** — Information in this document is believed to be accurate and reliable. However, NXP Semiconductors does not give any representations or warranties, expressed or implied, as to the accuracy or completeness of such information and shall have no liability for the consequences of use of such information.

**Right to make changes** — NXP Semiconductors reserves the right to make changes to information published in this document, including without limitation specifications and product descriptions, at any time and without notice. This document supersedes and replaces all information supplied prior to the publication hereof.

**Suitability for use** — NXP Semiconductors products are not designed, authorized or warranted to be suitable for use in medical, military, aircraft, space or life support equipment, nor in applications where failure or

malfunction of a NXP Semiconductors product can reasonably be expected to result in personal injury, death or severe property or environmental damage. NXP Semiconductors accepts no liability for inclusion and/or use of NXP Semiconductors products in such equipment or applications and therefore such inclusion and/or use is at the customer's own risk.

**Applications** — Applications that are described herein for any of these products are for illustrative purposes only. NXP Semiconductors makes no representation or warranty that such applications will be suitable for the specified use without further testing or modification.

**Limiting values** — Stress above one or more limiting values (as defined in the Absolute Maximum Ratings System of IEC 60134) may cause permanent damage to the device. Limiting values are stress ratings only and operation of the device at these or any other conditions above those given in the Characteristics sections of this document is not implied. Exposure to limiting values for extended periods may affect device reliability.

**Terms and conditions of sale** — NXP Semiconductors products are sold subject to the general terms and conditions of commercial sale, as published at <http://www.nxp.com/profile/terms>, including those pertaining to warranty, intellectual property rights infringement and limitation of liability, unless explicitly otherwise agreed to in writing by NXP Semiconductors. In case of any inconsistency or conflict between information in this document and such terms and conditions, the latter will prevail.

**No offer to sell or license** — Nothing in this document may be interpreted or construed as an offer to sell products that is open for acceptance or the grant, conveyance or implication of any license under any copyrights, patents or other industrial or intellectual property rights.

### Trademarks

Notice: All referenced brands, product names, service names and trademarks are the property of their respective owners.

## Contact information

For additional information, please visit: <http://www.nxp.com>

For sales office addresses, send an email to: [salesaddresses@nxp.com](mailto:salesaddresses@nxp.com)

## Revision history

### Revision history

Document ID	Release date	Data sheet status	Change notice	Supersedes
BLF147_6	20061205	Product data sheet	-	BLF147_5
Modifications:	• Correction made to <a href="#">page 9 "List of components"</a>			
BLF147_5	20061108	Product data sheet	-	BLF147_4
BLF147_4 (9397 750 11593)	20030901	Product specification	-	BLF147_3
BLF147_3 (9397 750 08411)	20010523	Product specification	-	BLF147_CNV_2
BLF147_CNV_2 (9397 750 xxxxx)	19971215	Product specification	-	-

Please be aware that important notices concerning this document and the product(s) described herein, have been included in section 'Legal information'.



© NXP B.V. 2006.

All rights reserved.

For more information, please visit: <http://www.nxp.com>

For sales office addresses, please send an email to: [salesaddresses@nxp.com](mailto:salesaddresses@nxp.com)

Date of release: 5 December 2006

Document identifier: BLF147\_6